

Single Pole (One location) or 3-Way (Multi-location)
Electronic Countdown Timer Switch
 Cat. No. LTB15, LTB30, LTB60, LTB02, LTB12 Lighted
 20A Resistive/Inductive, 1800W Incandescent, 1HP
 120VAC, 60Hz
INSTALLATION INSTRUCTIONS

WARNINGS AND CAUTIONS:

- To be installed and/or used in accordance with appropriate electrical codes and regulations.
- If you are unsure about any part of these instructions, consult an electrician.
- Leviton electronic countdown timer switches are not compatible with standard 3-way or 4-way switches. They must be used with compatible Vizia +® ON/OFF remote switches.
- Recommended minimum wall box depth is 2-1/2".

WARNINGS AND CAUTIONS:

- **Disconnect power at circuit breaker or fuse when servicing, installing or removing fixture.**
- Use only one (1) Leviton electronic countdown timer switch in a multi-location circuit with up to 9 coordinating remote switches without LEDs or up to 4 matching remote switches with LEDs.
- Maximum wire length from timer switch to all installed remote switches cannot exceed 300 ft (90 m).
- Use this device only with **copper or copper clad wire only**.

TOOLS NEEDED TO INSTALL YOUR TIMER SWITCH

- Slotted/Phillips Screwdriver Electrical Tape Pliers
 Pencil Cutters Ruler

Changing the color of your device:

Your device may include color options. To change color of the face, proceed as follows:

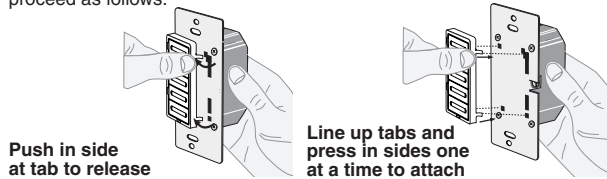

MAXIMUM LOAD PER TIMER FOR MULTI-DEVICE INSTALLATIONS			
Load	Single	Two Devices	More than 2 devices
Resistive Load	20A (2400W)	16A (1920W)	16A (1920W)
Incandescent Load	1800W	1800W	1800W
Inductive Load	20A	16A	16A
Motor Load	1HP	1HP	1HP

INSTALLING YOUR TIMER SWITCH

NOTE: Use check boxes when Steps are completed.

Step 1 **WARNING: TO AVOID FIRE SHOCK OR DEATH; TURN OFF POWER** at circuit breaker or fuse and test that power is off before wiring!

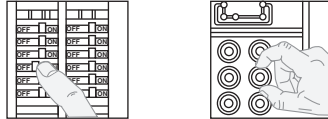

Step 2 **Identifying your wiring application (most common):**

NOTE: If the wiring in your wall box does not resemble any of these configurations, consult an electrician.

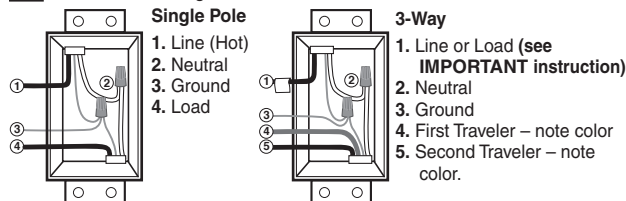

NOTE: For matching remote w/LEDs installation, the **First Traveler** becomes Line Hot.

IMPORTANT: For 3-Way applications, note that one of the screw terminals from the old switch being removed will usually be a different color (Black) or labeled Common. Tag that wire with electrical tape and identify as the common (Line or Load) in both the switch wall box and remote wall box.

Step 3 **Preparing and connecting wires:**

Pull off pre-cut insulation from timer switch leads. Make sure that the ends of the wires from the wall box are straight (cut if necessary). Remove insulation from each wire in the wall box as shown:



For non-standard wiring applications, refer to Wire Nut and Connector Size Chart

WIRE CONNECTOR / # OF COND. COMBINATION CHART	
1 - #12 w/ 1 to 3	#14, #16 or #18
2 - #12 w/ 1 to 2	#16 or #18
1 - #14 w/ 1 to 4	#16 or #18
2 - #14 w/ 1 to 3	#16 or #18

- Make sure that the ends of the wires from the wall box are **straight (cut if necessary)**.
- Remove insulation from each wire in the wall box as shown.
- **For Single-Pole Application, go to Step 4a.**

Step 4a **Single Pole Wiring Application:**

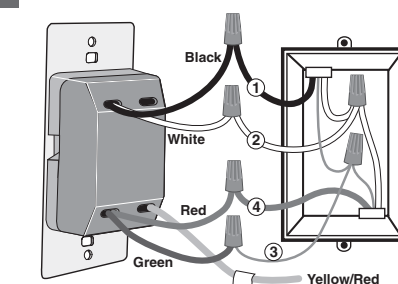

Insulating label:
 This wire is used in 3-way installations only.
 For single pole installations, do not remove this insulating label.

Step 4a cont'd

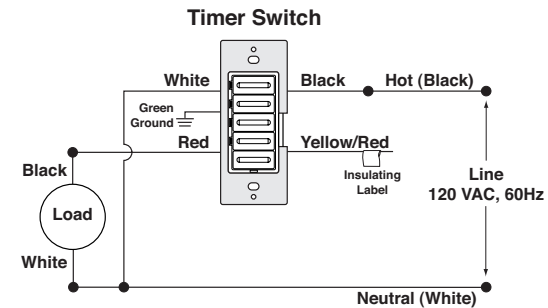

WIRING TIMER SWITCH:

Connect wires per **WIRING DIAGRAM** as follows:

- Green or bare copper wire in wall box to Green lead.
- Line Hot wall box wire to Black lead.
- Load wall box wire to Red lead.
- Line Neutral wall box wire to White lead.
- Timer Switch Yellow/Red lead should have Red insulation label affixed.
- **Proceed to Step 5.**

Step 4c 3-Way Wiring with Vizia + Matching Remote Switch (w/LED) Application:

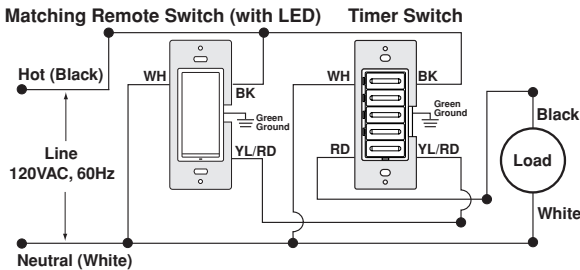
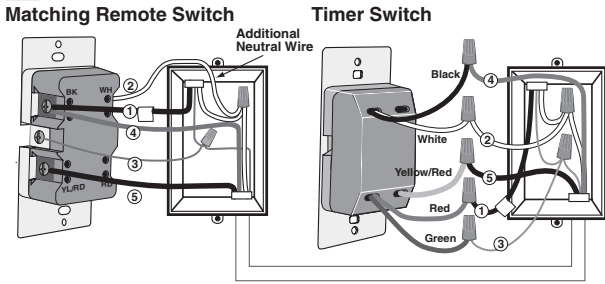

NOTE: The timer switch **must** be installed in a wall box that has a Load connection. The matching remote switch **must** be installed in a wall box with a Line Hot connection and a Neutral connection. A Neutral wire to the matching remote switch needs to be added as shown.

If you are unsure about any part of these instructions, consult an electrician.

NOTE: Maximum wire length from timer switch to all installed remote switches cannot exceed 300 ft (90 m).

WIRING VIZIA + MATCHING REMOTE SWITCH (wall box with Line Hot connection):

Connect wires per WIRING DIAGRAM as follows:

- Green or bare copper wire in wall box to Green terminal screw.
- Line Hot (common) wall box wire identified (tagged) when removing old switch and First Traveler to remote terminal screw marked "BK".
- Second Traveler wall box wire from switch to remote terminal screw marked "YL/RD" (**note wire color**). This traveler from the remote must go to the Yellow/Red lead on the timer switch.
- Line Neutral wall box wire to remote terminal screw marked "WH".

WIRING TIMER SWITCH (wall box with Load connection):

Connect wires per WIRING DIAGRAM as follows:

- Green or bare copper wire in wall box to Green lead.
- Load wall box wire identified (tagged) when removing old switch to Red lead.
- First Traveler Line Hot to Black lead.
- Remove Red insulating label from Yellow/Red lead.
- Second Traveler wall box wire (**note color as above**) to Yellow/Red lead. This traveler from the timer switch must go to the terminal screw on the remote switch marked "YL/RD".
- Line Neutral wall box wire to White lead.
- **Proceed to Step 5.**

Step 5 Testing your Timer Switch prior to mounting in wall box:

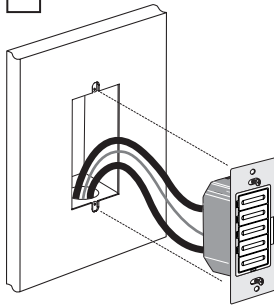

- Position all wires to provide room in outlet wall box for device.
 - Ensure that the word "TOP" is facing up on device strap.
 - Partially screw in mounting screws in wall box mounting holes.
- NOTE:** Dress wires with a bend as shown in diagram in order to relieve stress when mounting device.

- Restore power at circuit breaker or fuse.
 - Press any timer button to turn the load on.
- If the load does not turn ON, refer to the TROUBLESHOOTING section.**

Step 6 Timer Switch Mounting: TURN OFF POWER AT CIRCUIT BREAKER OR FUSE.

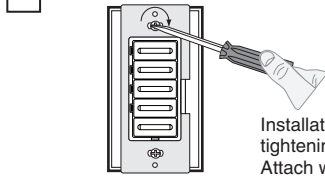

Installation may now be completed by tightening mounting screws into wall box. Attach wallplate.

Step 7 Restore Power:

Restore power at circuit breaker or fuse. **Installation is complete.**

FEATURES OF YOUR COUNTDOWN TIMER SWITCH

- Four (4) Timer buttons and an OFF button.
- Each timer button has an adjacent green LED to indicate the current countdown time.
- The green bottom LED is ON when the load is OFF and is OFF when the load is ON.
- Your timer switch can be easily programmed to function as 1 of 4 timers.
- LTB02 is not programmable as a 12 hour timer but can be programmed to function as any of the other timers.

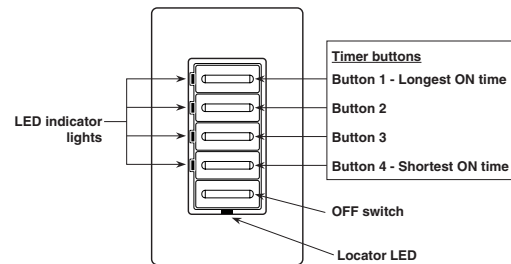

OPERATION

1. To turn the load ON press one of the timer buttons. The green LED adjacent to that button will illuminate and the timer will begin to countdown for the selected timer period.
2. To select a different countdown time press the button corresponding to the desired time. The LED adjacent to that button will illuminate and the timer will begin countdown from the new selection.
3. To turn the load OFF press the OFF button or wait until the selected amount of time has passed. The LED adjacent to each button will extinguish as time passes to the next preset level.

Timer Override

To override the Timer countdown press and hold the top button for several seconds. The locator LED will turn amber to indicate the EXTENDED ON state. In this state the timer will automatically turn OFF after 24 hours. To exit the EXTENDED ON state press any of the timer buttons or the OFF switch.

ADVANCED PROGRAMMING FEATURE

Timer Select Mode - You can change the time outs on your timer without buying a new device!

Your timer can be programmed to function as any of the timers in the table below:

Timer Switch Number	Buttons	Time outs
LTB02	1 (top timer button)	15m, 30m, 1hr, 2hr
LTB12	1 (top timer button)	2, 4, 8, 12 hours
LTB60	2	10, 20, 30, 60 minutes
LTB30	3	5, 10, 15, 30 minutes
LTB15	4 (bottom timer button)	2, 5, 10, 15 minutes
N/A	5 - OFF button	N/A

NOTE: If you change the ON times of your timer the printed face will no longer match the ON times. A timer change kit should be purchased to alleviate this situation.

To select different on times please follow the subsequent steps:

1. Press and hold the **1st** and **3rd** timer buttons to enter Select Timer Mode.
2. The current active Timer LED will flash green to indicate the device is in Select Timer Mode.
3. Press the button (from the table above) corresponding with the time outs you desire.
4. The new Timer button will briefly flash to demonstrate the timer mode chosen.
5. Pressing the OFF button will save programming and exit programming mode. The timer will also exit programming mode automatically if no buttons are pressed for 3 minutes.

Multi-Location Control

The Timer can be turned ON or OFF from any of the Vizia +[®] Remote Switch locations. The default ON time when a remote is pressed to turn the load ON will be the last countdown time chosen. The timer can be controlled from up to 10 locations using Vizia + Coordinating Remote Switches or up to 5 locations using Vizia + Matching Remote Switches.

TROUBLESHOOTING

- **Intermittent Operation**
 - Load has a bad connection.
 - Wires not secured firmly to leads of timer switch and/or remote switch.
- **Load does not turn ON and Locator LED does not turn ON**
 - Circuit breaker or fuse has tripped.
 - Load is burned out.
 - Neutral connection is not wired.
- **Remote does not operate load**
 - Ensure that total wire length does not exceed 300 ft (90 m).
 - Ensure that a neutral wire is used with matching remote switches.

NOTE: Sharing a neutral wire may cause improper operation. Connect all timers to the same phase or run a separate neutral to each phase.

For additional information, contact Leviton's Techline at 1-800-824-3005 or visit Leviton's website at www.leviton.com

Covered by one or more US & Foreign Patents and patents pending

© 2009 Leviton Manufacturing Co., Inc.

All Rights Including Trade Dress Rights Reserved

- Degree of protection provided: IP20
- Type of Action: 1Q

FCC COMPLIANCE STATEMENT

This device complies with Part 15 of the FCC Rules. Operation is subject to following two conditions: (1) this device may not cause harmful interference, and (2) this device must accept any interference received, including interference that may cause undesired operation of the device.

This equipment has been tested and found to comply with the limits for a Class B Digital Device, pursuant to Part 15 of the FCC Rules. These limits are designed to provide reasonable protection against harmful interference in a residential installation. This equipment generates, uses, and can radiate radio frequency energy and, if not installed and used in accordance with the instructions, may cause harmful interference to radio communications. However, there is no guarantee that interference will not occur in a particular installation. If this equipment does cause harmful interference to radio or television reception, which can be determined by turning the equipment OFF and ON, the user is encouraged to try to correct the interference by one or more of the following measures:

- Reorient or relocate the receiving Antenna.
- Increase the separation between the equipment and the receiver.
- Connect the equipment into an outlet on a circuit different from that to which the receiver is connected.
- Consult the dealer or an experienced radio/tv technician for help.

FCC CAUTION

Any changes or modifications not expressly approved by Leviton Manufacturing Co., Inc., could void the user's authority to operate the equipment.

LIMITED 5 YEAR WARRANTY AND EXCLUSIONS

Leviton warrants to the original consumer purchaser and not for the benefit of anyone else that this product at the time of its sale by Leviton is free of defects in materials and workmanship under normal and proper use for five years from the purchase date. Leviton's only obligation is to correct such defects by repair or replacement, at its option, if within such five year period the product is returned prepaid, with proof of purchase date, and a description of the problem to **Leviton Manufacturing Co., Inc., Att: Quality Assurance Department, 201 North Service Road, Melville, NY 11747**. This warranty excludes and there is disclaimed liability for labor for removal of this product or reinstallation. This warranty is void if this product is installed improperly or in an improper environment, overloaded, misused, opened, abused, or altered in any manner, or is not used under normal operating conditions or not in accordance with any labels or instructions. **There are no other or implied warranties of any kind, including merchantability and fitness for a particular purpose**, but if any implied warranty is required by the applicable jurisdiction, the duration of any such implied warranty, including merchantability and fitness for a particular purpose, is limited to five years. **Leviton is not liable for incidental, indirect, special, or consequential damages, including without limitation, damage to, or loss of use of, any equipment, lost sales or profits or delay or failure to perform this warranty obligation.** The remedies provided herein are the exclusive remedies under this warranty, whether based on contract, tort or otherwise.