

Riviera Towel Warmer

Dual Connection • 120 V

The Riviera is one of our most-loved towel warmers — and it's easy to see why. Its sculptural curved 3D profile and nine polished stainless steel bars bring everyday spa luxury to the bath, warming up to two large towels in beautiful, even comfort. What truly sets the Riviera apart is its Dual Connection design: use it as-is in any standard outlet, or have a licensed electrician hardwire it — with power running through the mounting leg, there's no cover plate and no gang box, just a clean, streamlined silhouette. And when you're ready to make it your own, the Riviera welcomes genuine Austrian crystal accents in four designer patterns.

- DUAL CONNECTION
- CURVED 3D DESIGN
- AUSTRIAN CRYSTAL ACCENTS



- 

**Brushed
Stainless
Steel**
- 

**Polished PVD
Gold**
- 

**Polished
Stainless
Steel**



Crafted from premium 304-grade stainless steel with built-in TempSmart protection, the Riviera pairs unmatched installation flexibility with timeless, elegant design.

EVERYDAY LUXURY, YOUR WAY

Features

The Riviera Towel Warmer combines a beautifully sculptural design with unmatched connection flexibility — and the option to make it uniquely yours with Austrian crystal accents. Every detail is designed for everyday luxury, effortless installation, and timeless style.



Dual Connection — Incredible Flexibility

The Riviera's standout feature. Use it as-is, plugged into any standard 120 V outlet — or have a licensed electrician hardwire it. One product, two installation paths, total flexibility for any project.



Sculptural 9-Bar Curved Design

Nine polished stainless steel bars in a curved 3D profile distribute heat evenly, warming up to two large towels or bathrobes while adding architectural dimension to the wall.



Premium Stainless Steel Construction

Crafted from durable 304-grade stainless steel with easy-to-clean curved bars — built to resist the everyday realities of a high-humidity bathroom.



No Cover Plate Required

Power connects inside the mounting leg — so there's no gang box and no cover plate to interrupt the design. The result is a remarkably clean, streamlined, balanced appearance on the wall.



Make It Yours — Optional Crystal Accents

Add your personality. The Riviera accepts genuine Austrian crystal accents in four designer patterns — an optional upgrade that turns a beautiful towel warmer into your own signature statement piece.



TempSmart Safe-Touch Heating

Built-in TempSmart technology automatically regulates the surface temperature, preventing the unit from exceeding 167°F (75°C) for safe, consistent warmth.

PRODUCT SPECIFICATIONS

Product Specifications

Explore the engineering behind the Riviera's flexible, sculptural design. The following specifications are shared across every Riviera — for the details that vary by finish, see the finish comparison on the following page. From its premium 304-grade stainless steel construction to its Dual Connection engineering and TempSmart safe-touch heating, every specification reflects our commitment to durable, safe, and beautifully flexible radiant warmth.

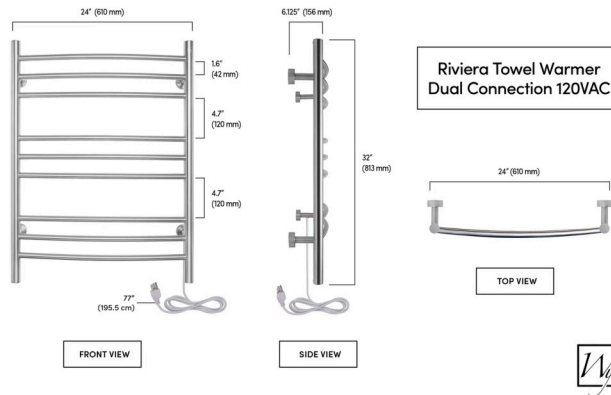

Connection	Dual Connection (Plug-In or Hardwired)
Voltage	120 V
Watts / Amps	150 W / 1.25 A
Resistance	96 Ω
Heat Output	512 BTU/hr
Plug Type	NEMA 5-15 (Type B)
Cord Length	77"
Cord Color	White
Material	304-Grade Stainless Steel
Bar Shape / Count	Round / 9 Bars (Curved 3D, 3 groups of 3)
Integrated Control	Integrated LED On/Off Switch
Towel Capacity	Up to 2 Large Towels
Dimensions (W × H × D)	24" × 32" × 6 1/8" (61.0 cm × 81.3 cm × 15.6 cm)
Mounting Footprint	21 1/8" (550 mm) W × 21" (532 mm) H
Base Weight	10.4 lbs / 4,717 g
TempSmart Safety Limit	149°F - 167°F / 65°C - 75°C
Ingress Protection	IP44
Listing	cETLus Listed (ETL #5008694)
Towel Warmer Warranty	2-Year Limited Warranty
Crystal Accent Warranty	2-Year Warranty

THREE FINISHES

Start With the Finish That's Right for You

Every Riviera shares the same curved 9-bar frame and Dual Connection engineering — choose the base finish that sets the tone for your space. Each is crafted to its own standard, from bright bare stainless to a rich PVD gold.

SKU	<u>TW-R09PS-HP</u>	<u>TW-R09BS-HP</u>	<u>TW-R09GS-HP</u>
MSRP	\$445	\$475	\$800
Finish	Polished Stainless Steel	Brushed Stainless Steel	Polished Gold PVD (Physical Vapor Deposition)
Collar Finish	Polished Stainless	Brushed Stainless	Polished Gold



Luminous Polished Stainless

A bright, reflective shine and timeless, classic elegance — pairs beautifully with both traditional and transitional bathrooms.

Soft Brushed Stainless

A refined, satin-brushed surface that hides fingerprints and complements contemporary, understated palettes.

Rich Polished PVD Gold

A warm, luxurious gold applied by durable Physical Vapor Deposition (PVD) — a striking, high-end statement finish.

CONTROL OPTIONS

SMART HEATING

Towel Warmer Control Options

Enhance your daily ritual with effortless control over your towel warmer. Whether you prefer the simplicity of a manual switch or the sophistication of smart home integration, our range of control options ensures your towels are perfectly warm, exactly when you need them.

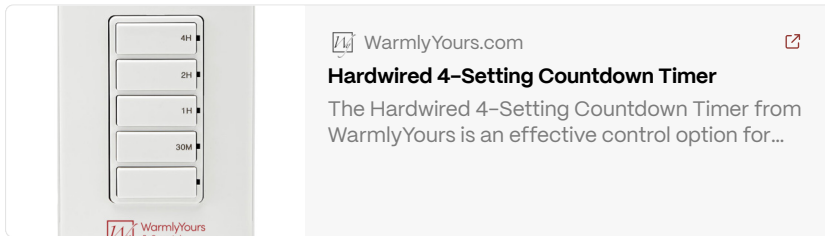

Simple timer, no programming. Select one of four preset countdown durations (30 min, 1 hr, 2 hr, 4 hr) — the warmer shuts off automatically.

GK16-30090-0006 | \$69

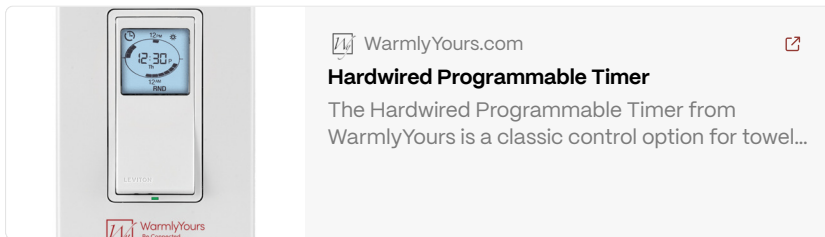

Scheduled daily heating. Program up to 50 on/off events on a 7-day schedule with a backlit LCD display.

GK16-30090-0002 | \$89

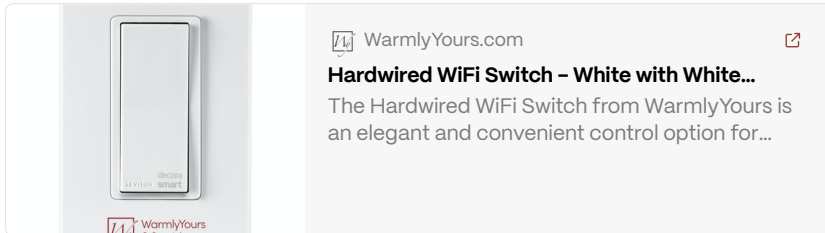

Smart home & voice control. Control remotely via the My Leviton app. Compatible with Amazon Alexa and Google Assistant — no hub required.

GK16-30090-0003 | \$109



Hardwired controls are compatible with hardwired installations only. For plug-in installations, contact us for plug-in timer options.

PERSONALIZATION **CRYSTAL ACCENTS**

Make the Riviera Uniquely Yours

Every Riviera Towel Warmer includes standard stainless steel collars — the decorative caps where each heated bar meets the wall. To infuse your personal style and elevate the aesthetic, you can choose to replace these with an optional set of genuine Austrian crystal collars. These exquisite accents transform your towel warmer into a bespoke piece, reflecting your unique taste.

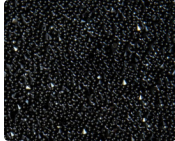
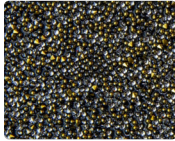

The crystal collar kits are designed for effortless integration. Each four-piece kit fully replaces the standard collars and can be installed in minutes, requiring no special tools and no electrician. This convenient design allows you to add a touch of sparkle immediately or upgrade your warmer's look anytime you desire. Explore our four designer patterns below:

Crystal Pattern	Image	Color Story	Upgrade Kit Price
Platinum		Dove gray to pearl and royal silver, offering a cool, sophisticated shimmer.	\$110
Slate		Pewter to sharkskin gray and silver, perfect for modern, understated elegance.	\$110
Midnight		Volcanic glass to inky night and onyx, providing a dramatic and luxurious depth.	\$115
Spice		Champagne to amber and antique gold, radiating a warm, opulent glow.	\$120

Each Crystal Collar kit is sold separately as a 4-piece set and is compatible with any Riviera towel warmer finish. The crystal accents carry a 2-year warranty.

- Considering a different aesthetic? If you prefer a flat-bar design with the same Dual Connection flexibility and crystal collar options, explore the [Infinity](#) 10-bar towel warmer. You can also browse our full [Towel Warmer collection](#) to discover more radiant heating solutions.

CONTROL OPTIONS

SMART HEATING

A WiFi Switch That Matches Your Crystals

Added crystal accents? Complete the look with a Hardwired WiFi Switch available in the same four Austrian crystal patterns — the only smart control designed to match your towel warmer.

The only smart control crafted to match your towel warmer, finish for finish. Choose the perfect **crystal-matched WiFi switch** to complete your Riviera.



Crystal-Matched WiFi Switch

Choose Platinum, Slate, Midnight, or Spice to coordinate with your crystal accents for a perfectly unified design.



Full Smart Home Integration

Control your Riviera from anywhere via WiFi, and pair seamlessly with Amazon Alexa, Google Assistant, Nest, and IFTTT for voice and automated scheduling.



Set It and Forget It

Schedule warm towels for every morning, automate by routine, or switch on remotely before you step out of the shower. Effortless comfort, every day.



GK16-03-SC-PT-W | \$219



GK16-03-SC-SL-W | \$219



GK16-03-SC-MD-B | \$229



GK16-03-SC-SP-B | \$234

Two Ways to Connect — Your Choice

The Riviera's Dual Connection design gives you complete flexibility. Use it as a simple plug-in, or have it hardwired — either way, no gang box or cover plate is required, because power connects inside the mounting leg.

Option A — Plug-In (No Electrician)

Mount the Brackets

Using the included template and hardware kit, secure the wall brackets near a standard 120 V outlet. Do **not** rough in a junction box.

Hang & Plug In

Mount the Riviera onto the brackets and plug the 77" cord into the outlet.

Switch On

Flip the integrated on/off switch and enjoy.

Option B — Hardwired (Licensed Electrician)

Mount the Brackets

Secure the brackets at your chosen location. No gang box required.

Modify the Connection

A licensed electrician modifies the cord for a hardwired connection — power runs through the leg, so no cover plate is needed.

Power On

Restore power at the breaker and enjoy a clean, cord-free, streamlined look.

[View Installation Manual](#)

ORDER INFORMATION

How to Order — It's Easy!

Start with the Riviera, choose how you'd like to connect, and add your crystal accents to make it yours — the Riviera adapts to your project, not the other way around.

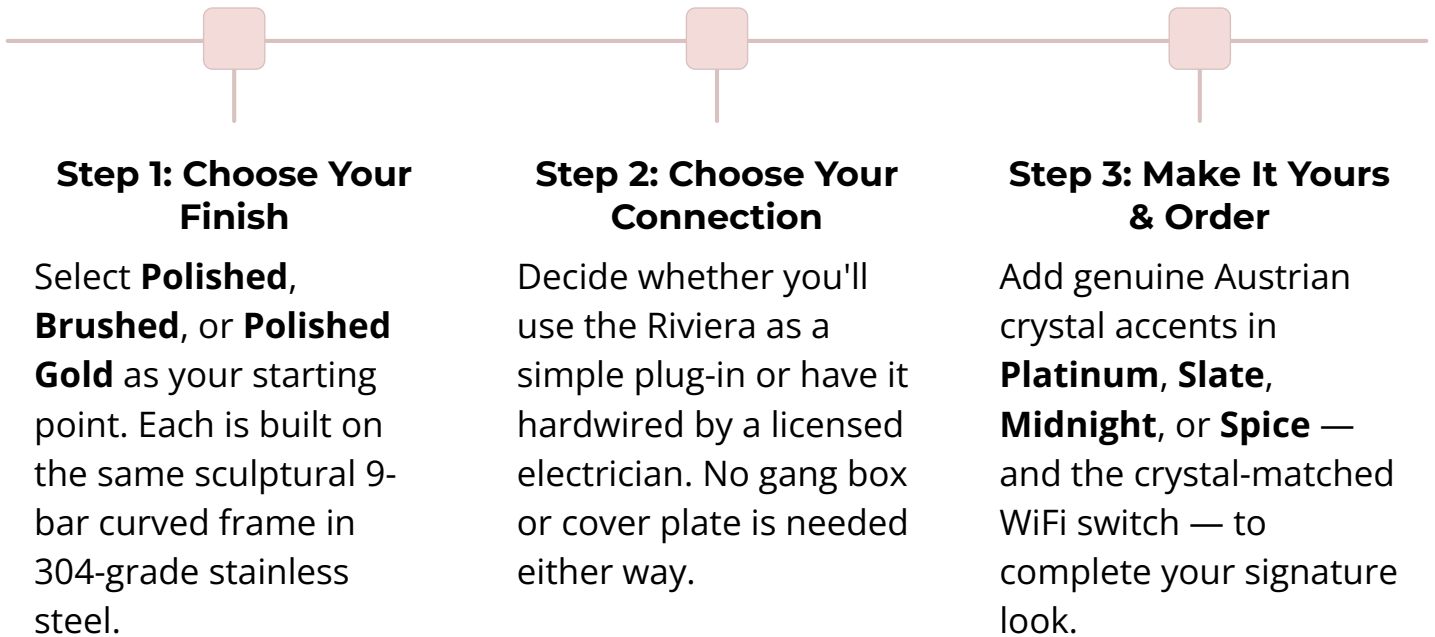

 **GOOD TO KNOW:** The Riviera's power connects inside the mounting leg — so even a hardwired installation needs no junction box or cover plate, for a beautifully streamlined result.

 **Questions about choosing the perfect finish, connection, or crystals for your project?** Contact us — we're happy to help.

[Contact Us](#)