

4 Poles (2-2 pole relays)
120 VAC Coils

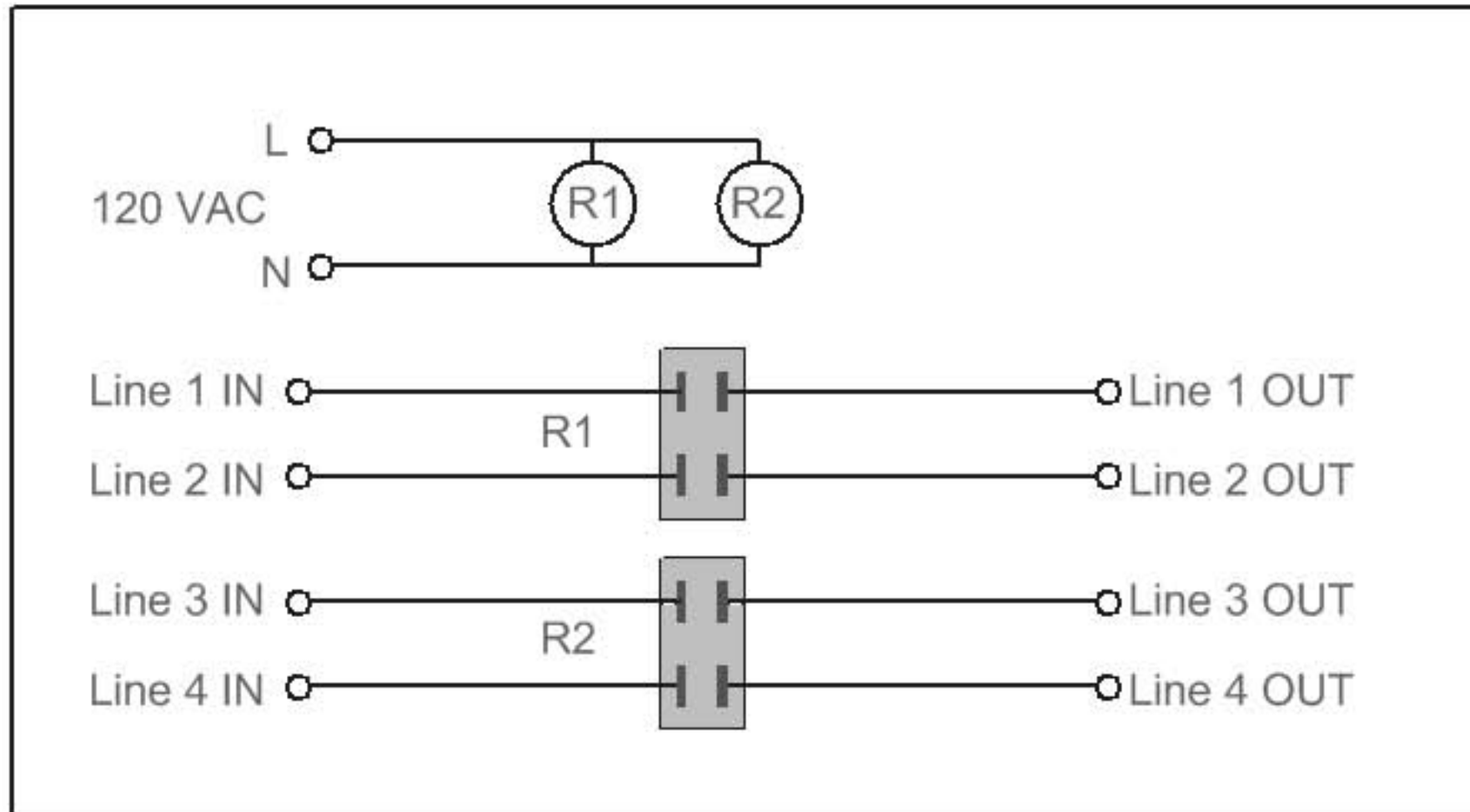

Note: "Line 1 IN" means the power coming into the relay panel from the circuit breaker.
"Line 1 OUT" means the power going out to the heating cable or heating mat.