

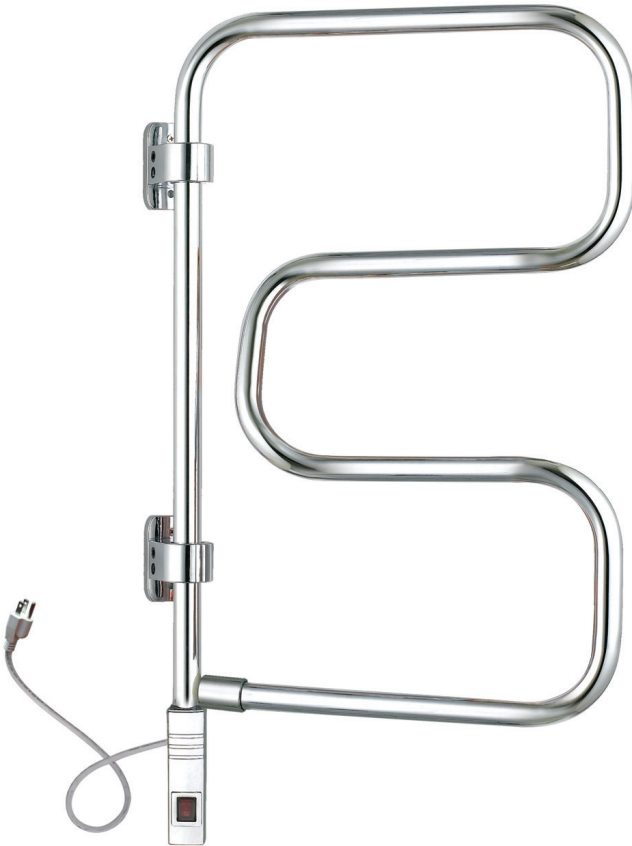

WarmlyYours

Radiant Heating Systems

Experts since 1999



# Installation & Operation Manual for WarmlyYours Towel Warmers

Thank you for choosing a finely crafted Towel Warmer from the Elements™ Collection by WarmlyYours. Now you can enjoy the luxury of a warm towel everyday. These models are so easy to install and use. Just plug the Towel Warmer unit into a standard 120V outlet, pre-heat your towel warmer and enjoy a warm, dry towel or bathrobe upon stepping from the shower.

All of the necessary installation and operation instructions are included in this manual. Please read the instructions carefully before installing and operating your towel warmer. If you encounter any difficulties while installing your unit, installation support is available by telephone between the hours of 8:00am-5:30pm CST, Monday through Friday by calling **(800) 875-5285**. Please reference the model number on the Towel Warmer label when you call. For label location, see page 11, Diagram A.

## **SAFETY INFORMATION**



- Towel Warmers are designed to warm towels and bathrobes only and should not be used for any other purpose.
- Never stand, sit, or hang on the Towel Warmer unit.
- Never allow children to play on or with the Towel Warmer. Close supervision is necessary when using any electrical appliance by or near children.
- Unplug unit and ensure that the electrical circuit breaker is shut off at the main panel before wiring, repairing, or servicing your Towel Warmer.
- All wiring must be in accordance with the National Electrical Code and should be performed by a licensed professional who is certified to do electrical wiring.
- Never place your Towel Warmer inside a shower, sauna or steam room or immerse in water for any reason.
- Never attempt to warm more than 2 towels on the Towel Warmer at any time. Overloading the Towel Warmer will cause the unit to become extremely hot and may result in a burn if touched.
- To provide continued protection against risk of electric shock, plug the unit into properly grounded outlets only.
- Approved for Household use only; Do not use outdoors.
- Never operate any electrical appliance with a damaged cord or plug.

## **CLEANING INFORMATION**

Unplug the Towel Warmer before cleaning. Clean the Towel Warmer with a soft, non-abrasive, damp cloth while warm. Once the Towel Warmer has cooled, lightly polish with a soft dry cloth. Never use abrasive cleaning powders, metal polish, chlorine or acid based cleaners on any part of the Towel Warmer.

## INSTALLATION

This appliance must be installed in accordance with the instructions in the manual and the NEC guidelines relating to electrical fixtures in bathrooms. We recommend that the Towel Warmer be plugged into a GFCI protected circuit.

Install the Towel Warmer as close to an electrical outlet as possible. If an extension cord becomes necessary, always use a grounded 3-wire extension cord. Confirm that the cord's electrical rating is at least as high as the electrical rating of the Towel Warmer. Ensure that the extension cord is a sufficient length to reach the outlet so as not to put undue strain on the cord. Use caution when arranging the cord to prevent tripping, snagging, or unintentional pulling (especially by children).

### Tools Required

- Use to make holes in dry wall and studs as required
- Use to tighten the mount with screws into the drywall anchors
- Use to sink the anchors into the drywall
- Use to tighten the mounting hardware bolts onto the pivot model of Towel Warmer (TW-E4PCP)
- Use to make sure that the Towel Warmer is mounted level
- Use to measure the distance between Towel Warmer mounting brackets to ensure that they mount in line

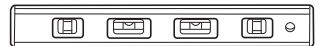
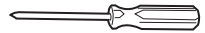
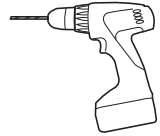

**Note:** Use other mounting hardware suitable for wall substrate when required.

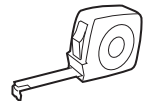

## Affixing the Towel Warmer to the Wall

**NOTE:** Install the Towel Warmer no less than 1 foot from the floor and near an electrical outlet. The electrical outlet must be properly grounded. Position the brackets on the Towel Warmer to ensure that the Towel Warmer is firmly affixed to the wall. See page 6 for for bracket assembly and installation recommendations.

### Step 1

Draw a diagram of the recommended location of the brackets on the Towel Warmer box to create a template (see Step 2 for template instructions). Two brackets must be mounted directly to a stud (see page 5 anchor points).

### Step 2

#### Create the Template:

- Attach brackets into recommended position on the Towel Warmer (see page 6 for recommended bracket assembly).
- Place Towel Warmer on the box (or a large sheet of paper) and lay on a flat surface with brackets facing downwards.
- Mark the location of the brackets on the template.

### Step 3

Use the template as a guide to mark the wall with the correct locations of the brackets. Make sure two of the brackets are lined up with a wall stud. Ensure that all anchor points are clear of existing electrical or mechanical systems.

### Step 4

Using the template, check to make sure that the Towel Warmer will be level once installed.

### Step 5

Drill holes as required at the marked locations and install the brackets into the wall using the hardware that has been provided. Use the drywall anchors that are supplied for any bracket which is not being installed into a stud.

**Step 6**

With the brackets now in place, adjust the Towel Warmer to desired position and fully tighten the screws into place.

**Step 7**

Plug the Towel Warmer into a GFCI 120V, 15A electrical outlet. Enjoy!

# Affixing the Towel Warmer to the Wall

## WARNING

Measure all dimensions prior to rough-in and installation.

Elements™ model: TW-E4PCP

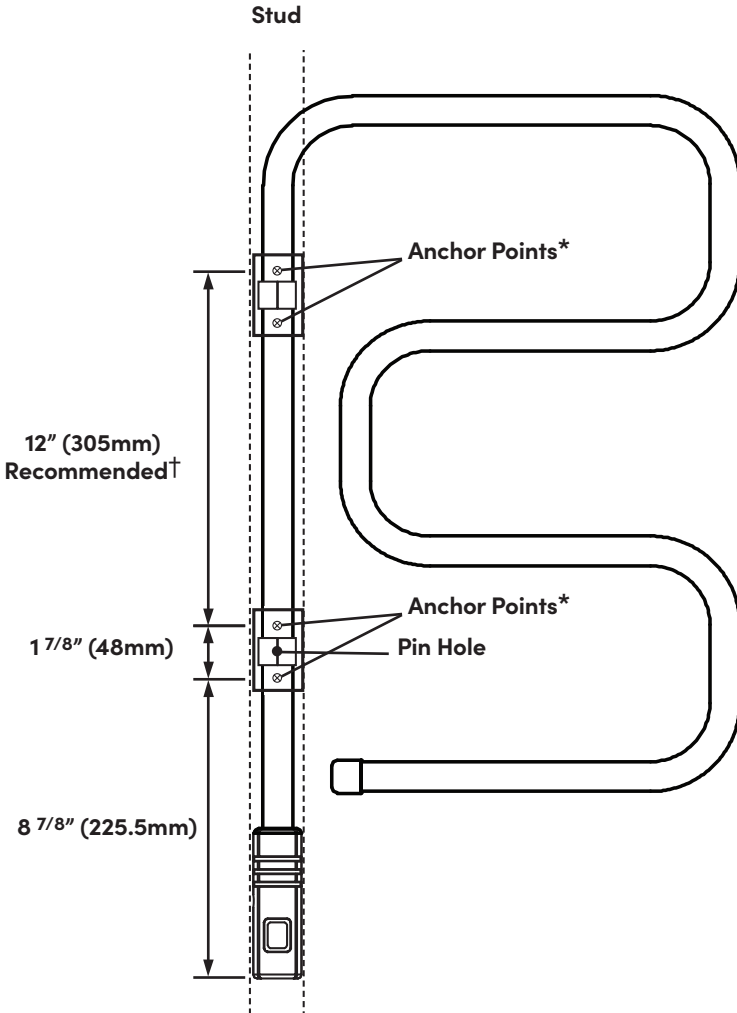

\* **Note:** Anchor points must be attached to a stud.









† **Note:** 12" between brackets is recommended, but the top bracket can move up to 2" vertically as desired.

# Bracket Assembly and Installation Diagrams

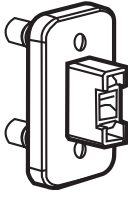
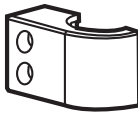
**WARNING** 

Measure all dimensions prior to rough-in and installation.

**Elements™ model: TW-E4PCP (KIT AK50-56010-0000)**

<p><b>A</b></p>  <p>Bolt, Anchor 6x70mm Hex Head 0005-56390-0000 Quantity 4</p>	<p><b>B</b></p>  <p>Bolt, Clamping Hex, Socket M6x40 0005-56390-0001 Quantity 4</p>	<p><b>F</b></p>  <p>Bracket, Mounting 0005-56110-0000 Quantity 2</p>	<p><b>G</b></p>  <p>Clamp, Half 0005-56110-0001 Quantity 4</p>	<p><b>I</b></p>  <p>Wrench, Hex Key 5mm 0005-51900-0002 Quantity 1</p>
<p><b>C</b></p>  <p>Washer 0005-56490-0000 Quantity 4</p>	<p><b>D</b></p>  <p>Nut, M6 0005-56690-0000 Quantity 4</p>		<p><b>H</b></p>  <p>Sleeve, Half 0005-56190-0000 Quantity 4</p>	<p><b>J</b></p>  <p>Anchor, Wall #8 0005-56500-0000 Quantity 4</p>
<p><b>E</b></p>  <p>Pin 0005-56890-0000 Quantity 1</p>				

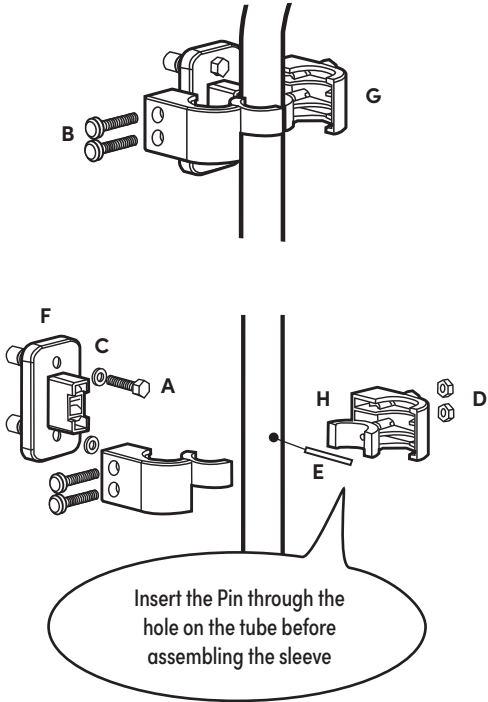

Insert the Pin through the hole on the tube before assembling the sleeve

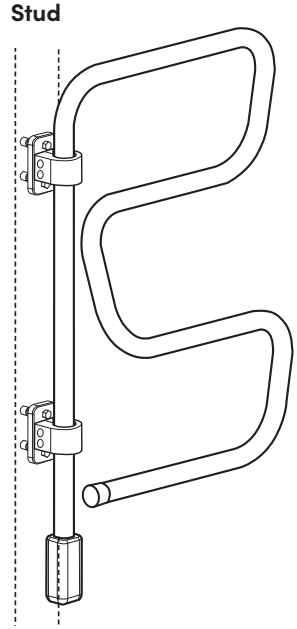

## Bracket Assembly and Installation Diagrams

### OPERATION

All models of the Elements™ Towel Warmer Collection include an easy and accessible “on/off” button. Turn the power “on” by pressing the red “on/off” button located on the unit. Refer to **Diagram A**. The “on” setting is indicated by an “I” and the “off” setting is indicated by “O.”

A light will illuminate when the button is switched to the “on” position. In approximately 10-15 minutes, your Towel Warmer will be warm to the touch. Allow 45 minutes for your Towel Warmer to reach optimal temperature. Your Towel Warmer is designed to gradually warm towels over the course of a day and works best when towels are left to hang for at least 3 hours.

Turn your Towel Warmer off and unplug it when not in use.

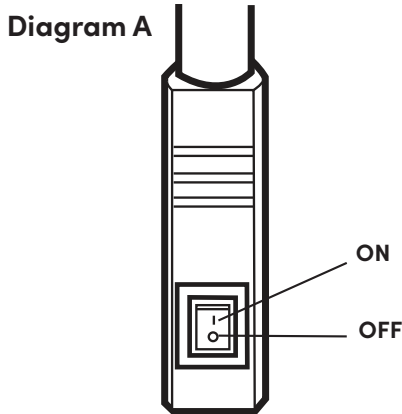

### On Mode

Towel Warmer runs at 100% power and the towels will reach temperatures between 75° F and 95° F depending on the following: operation time, number and size of towels, type of towels, and ambient room temperature.

## SPECIFICATIONS

Model	Name	Dimensions	Voltage (volts)	Heat Output (watts)	Resistance (ohms)	Amperage (amps)
TW-E4PCP	Elements™	16.3"Wx28.5"Hx3.5"D	120	60	240	0.50

### Product Construction - Towel Warmer

The UL Listed Towel Warmer is constructed with continuous 1” heavy gauge SPHC steel tubing. The finished assembly is chrome plated and is heated by a UL listed wire which is designed for rapid and safe heating.

The mounting brackets are chrome plated and manufactured with ABS (acrylonitrile butadiene styrene) plastic which can withstand temperatures up to 212 degrees Fahrenheit (100 degrees Celsius). The surface temperature of the Towel Warmer unit will reach temperatures between 131 to 149 degrees Fahrenheit (55-65 degrees Celsius).

### Product Construction – “On/Off” Button Control

The “on/off” button is humidity sealed with a plastic cover and secured with a grommet which is embedded into the switch assembly, making the unit suitable for installation in damp locations such as bathrooms.

### Connection Method

The connection method is a 18 AWG grounded plug and a UL Listed cord.

## **SAFETY GUIDELINES**

The main electrical line feeding the Towel Warmer must incorporate a Ground Fault Circuit Interrupter (GFCI) for North America.

### **WarmlyYours - Elements Towel Warmer Warranty**

WarmlyYours.com Inc. warrants the WarmlyYours Towel Warmers (“the Product”) to be free from defects in materials and workmanship for one year from the date of sale, provided that the Product is installed in accordance with the accompanying Installation and Operation Manual, and any special written design or installation guidelines provided by WarmlyYours.com Inc. for this product, the National Electric Code (NEC), and all applicable local building and electrical codes. Controls sold under the WarmlyYours.com Inc. name are warranted for one year from the date of sale.

Any suspected defect must be reported by registered letter immediately upon discovery. The determination of such a defect must be made by WarmlyYours.com Inc., or its authorized representative only. This warranty is null and void if the product is improperly installed, improperly operated, or abused.

WarmlyYours.com Inc. assumes no responsibility under this warranty for any damage to the product caused by any trades person, or visitor on the job site, or damage caused as a result of post installation work.

Under this Limited Warranty, WarmlyYours.com Inc. will provide the following remedy:

If the Product is determined to be defective in materials and workmanship, and has not been damaged as a result of misuse or misapplication, WarmlyYours.com Inc. will refund the original purchase price or replace the Towel Warmer, at WarmlyYours.com Inc. expense. WarmlyYours.com Inc. will not be liable for the labor required to replace the Towel Warmer.

The Limited Warranty is null and void if the project owner or his representative attempts to repair the Product without receiving authorization. Upon notification of a real or possible problem, WarmlyYours.com Inc., will issue an Authorization to Proceed under the terms of the Limited Warranty.

**WARMLYYOURS.COM INC. DISCLAIMS ANY WARRANTY NOT PROVIDED HEREIN, INCLUDING ANY IMPLIED WARRANTY OF MERCHANTABILITY OR IMPLIED WARRANTY OF FITNESS FOR A PARTICULAR PURPOSE.**

WARMLYYOURS.COM INC. FURTHER DISCLAIMS ANY RESPONSIBILITY FOR SPECIAL, INDIRECT, SECONDARY, INCIDENTAL, OR CONSEQUENTIAL DAMAGES ARISING FROM OWNERSHIP OR USE OF THIS PRODUCT, INCLUDING INCONVENIENCE OR LOSS OF USE. THERE ARE NO WARRANTIES WHICH EXTEND BEYOND THE FACE OF THIS DOCUMENT. NO AGENT OR REPRESENTATIVE OF WARMLYYOURS.COM INC. HAS ANY AUTHORITY TO EXTEND OR MODIFY THIS WARRANTY UNLESS SUCH EXTENSION OR MODIFICATION IS MADE IN WRITING BY A CORPORATE OFFICER.

Please fill in the warranty card information or call **(800) 875-5285** to register via telephone.

### **IMPORTANT NOTICE FOR QUÉBEC CONSUMERS:**

WarmlyYours does not provide repair services for this product. We offer replacement hardware kits (mounting brackets, screws, installation accessories) and on/off switches, but the heating element (main heating component) is not available as a replacement part. If your towel warmer fails within the warranty period, we will replace the entire unit according to our warranty policy. Our technical support team is available 24/7 by phone for installation and troubleshooting assistance. For full details, see our Return Policy. This notice is provided in accordance with Québec's Consumer Protection Act, section 39 (as amended in 2025).